

## LME49722

# Low Noise, High Performance, High Fidelity Dual Audio Operational Amplifier

### General Description

The LME49722 is part of the ultra-low distortion, low noise, high slew rate operational amplifier series optimized and fully specified for high performance, high fidelity applications. Combining advanced leading-edge process technology with state-of-the-art circuit design, the LME49722 audio operational amplifiers deliver superior audio signal amplification for outstanding audio performance. The LME49722 combines extremely low voltage noise density (1.9nV/ $\sqrt{\text{Hz}}$ ) rate with vanishingly low THD+N (0.00002%) to easily satisfy the most demanding audio applications. To ensure that the most challenging loads are driven without compromise, the LME49722 has a high slew rate of  $\pm 22\text{V}/\mu\text{s}$  and an output current capability of  $\pm 28\text{mA}$ . Further, dynamic range is maximized by an output stage that drives  $2\text{k}\Omega$  loads to within 1V of either power supply voltage.

The LME49722 has a wide supply range of  $\pm 2.5\text{V}$  to  $\pm 18\text{V}$ . Over this supply range the LME49722 maintains excellent common-mode and power supply rejection, and low input bias current. This Audio Operational Amplifier achieves outstanding AC performance while driving complex loads with values as high as  $100\text{pF}$  with gain value greater than 2. Directly interchangeable with LME49720, LM4562 and LME49860 for similar operating voltages.

### Key Specifications

■ Wide Operating Voltage Range	$\pm 2.5\text{V}$ to $\pm 18\text{V}$
■ Equivalent Noise (Frequency = 1kHz)	1.9nV/ $\sqrt{\text{Hz}}$ (typ)
■ Equivalent Noise (Frequency = 10Hz)	2.8nV/ $\sqrt{\text{Hz}}$ (typ)

■ PSRR	120dB (typ)
■ Slew Rate	$\pm 22\text{V}/\mu\text{s}$ (typ)
■ THD+N ( $A_V = 1$ , $V_{\text{OUT}} = 3V_{\text{RMS}}$ , $f_{\text{IN}} = 1\text{kHz}$ )	
$R_L = 2\text{k}\Omega$	0.00002% (typ)
$R_L = 600\Omega$	0.00002% (typ)
■ Open Loop Gain ( $R_L = 600\Omega$ )	135dB (typ)
■ Input Bias Current	50nA (typ)
■ Voltage Offset	$\pm 0.02\text{mV}$ (typ)

### Features

- Easily drives  $600\Omega$  loads
- Optimized for superior audio signal fidelity
- Output short circuit protection
- PSRR and CMRR exceed 120dB (typ)

### Applications

- Ultra high quality audio amplification
- High fidelity preamplifiers, phono preamps, and multimedia
- High performance professional audio
- High fidelity equalization and crossover networks with active filters
- High performance line drivers and receivers
- Low noise industrial applications including test, measurement, and ultrasound

### Typical Application

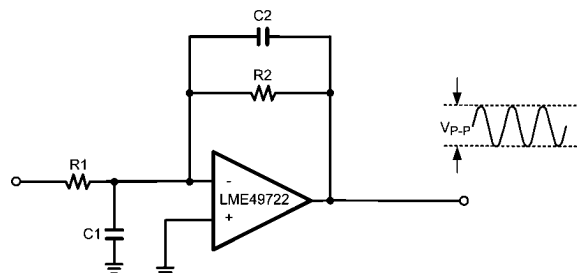

$f_{\text{MAX}} = > 300\text{ kHz}$  for  $V_{\text{p-p}} = 20\text{V}$ ,  $R_2 \approx R_1$ ,  $C_2 \approx C_1$

30057910

FIGURE 1. Wide Bandwidth Low Noise Low Drift Amplifier

# Connection Diagram

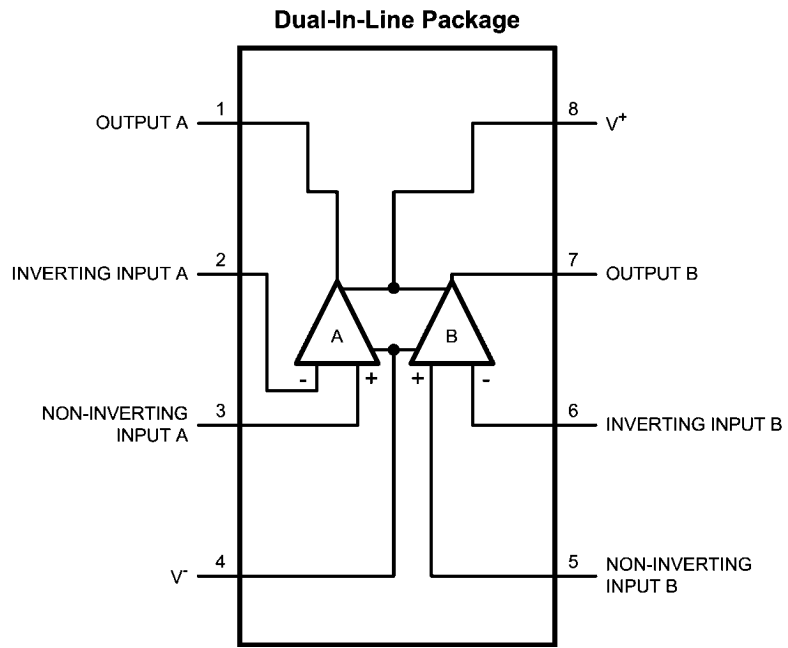

**Order Number LME49722MA**  
**See NS Package Number — M08A**

30057955

**Absolute Maximum Ratings** (Notes 1, 2)

If Military/Aerospace specified devices are required, please contact the National Semiconductor Sales Office/ Distributors for availability and specifications.

Supply Voltage ( $V_S = V_{CC} - V_{EE}$ )	38V
Storage Temperature	-65°C to 150°C
Input Voltage	(V-) - 0.7V to (V+) + 0.7V
Output Short Circuit (Note 3)	Continuous
ESD Susceptibility (Note 4)	2000V
ESD Susceptibility (Note 5)	200V

Junction Temperature ( $T_{JMAX}$ )	150°C
Thermal Resistance	
$\theta_{JA}$	154°C/W
$\theta_{JC}$	27°C/W

**Operating Ratings**

Temperature Range	
$T_{MIN} \leq T_A \leq T_{MAX}$	-40°C $\leq$ $T_A$ $\leq$ 85°C
Supply Voltage Range	$\pm 2.5V \leq V_S \leq \pm 18V$

**Electrical Characteristics for the LME49722** (Notes 1, 2) The following specifications apply for  $V_S = \pm 15V$  and  $\pm 18V$ ,  $R_L = 2k\Omega$ ,  $f_{IN} = 1kHz$  unless otherwise specified. Limits apply for  $T_A = 25^\circ C$ ,

Symbol	Parameter	Conditions	LME49722		Units (Limits)
			Typical	Limit	
			(Note 6)	(Note 7)	
THD+N	Total Harmonic Distortion + Noise	$A_V = 1$ , $V_{OUT} = 3V_{rms}$ $R_L = 2k\Omega$ $R_L = 600\Omega$	0.00002 0.00002	0.00009	% % (max)
IMD	Intermodulation Distortion	$A_V = 1$ , $V_{OUT} = 3V_{RMS}$ Two-tone, 60Hz & 7kHz 4:1	0.00002		%
GBWP	Gain Bandwidth Product	$f_{IN} = 100kHz$	55	45	MHz (min)
SR	Slew Rate	$A_V = 1$ , $V_{OUT} = 10V_{P-P}$	$\pm 22$	$\pm 15$	V/ $\mu s$ (min)
FPBW	Full Power Bandwidth	$V_{OUT} = 1V_{P-P}$ , -3dB referenced to output magnitude at $f = 1kHz$	12		MHz
$t_s$	Settling time	$A_V = -1$ , 10V step, $C_L = 100pF$ 0.1% error range	1.2		$\mu s$
$e_{INV}$	Equivalent Input Voltage Noise	$f_{BW} = 20Hz$ to 20kHz	0.25	0.35	$\mu V_{RMS}$ (max)
$e_N$	Equivalent Input Voltage Density	$f = 1kHz$ $V_S = \pm 15V$ $V_S = \pm 18V$	1.9 1.9	2.5	$nV\sqrt{Hz}$ $nV\sqrt{Hz}$ (max)
		$f = 10Hz$ $V_S = \pm 15V$ $V_S = \pm 18V$	2.8 3.2		$nV\sqrt{Hz}$ $nV\sqrt{Hz}$
$I_n$	Current Noise Density	$f = 1kHz$ $f = 10Hz$	2.6 6		$pA\sqrt{Hz}$ $pA\sqrt{Hz}$
$V_{OS}$	Offset Voltage	$V_{CM} = 0V$	$\pm 0.02$	$\pm 0.7$	mV (max)
PSRR	Power Supply Rejection Ratio	$\Delta V_S = 20V$ (Note 8)	120	110	dB (min)
ISO <sub>CH-CH</sub>	Channel-to-Channel Isolation	$f_{IN} = 1kHz$	136		dB
		$f_{IN} = 20kHz$	135		dB
$I_B$	Input Bias Current	$V_{CM} = 0V$ $V_S = \pm 15V$ $V_S = \pm 18V$	50 53	200	nA nA (max)
$\Delta I_{OS}/\Delta Temp$	Input Bias Current Drift vs Temperature	-40°C $\leq$ $T_A$ $\leq$ 85°C	0.1		nA/°C
$I_{OS}$	Input Offset Current	$V_{CM} = 0V$ $V_S = \pm 15V$ $V_S = \pm 18V$	25 32	100	nA nA (max)

Symbol	Parameter	Conditions	LME49722		Units (Limits)
			Typical	Limit	
			(Note 6)	(Note 7)	
$V_{IN-CM}$	Common-Mode Input Voltage Range	$V_S = \pm 15V$	+14.0 -13.9	$(V_{CC}) - 2.0$ $(V_{EE}) + 2.0$	V (min) V (min)
		$V_S = \pm 18V$	+17.0 -16.9	$(V_{CC}) - 2.0$ $(V_{EE}) + 2.0$	V (min) V (min)
CMRR	Common-Mode Rejection	$-10V \leq V_{CM} \leq 10V$	128	110	dB (min)
$Z_{IN}$	Differential Input Impedance		30		k $\Omega$
$Z_{CM}$	Common Mode Input Impedance	$-10V \leq V_{CM} \leq 10V$	1000		M $\Omega$
$A_{VOL}$	Open Loop Voltage Gain	$-12V \leq V_{OUT} \leq 12V, R_L = 600\Omega$	135	120	dB
		$-12V \leq V_{OUT} \leq 12V, R_L = 2k\Omega$	140		dB
		$-12V \leq V_{OUT} \leq 12V, R_L = 10k\Omega$	140		dB
$V_{OM}$	Output Voltage Swing	$V_S = \pm 15V$ $R_L = 600\Omega$ $R_L = 2k\Omega$ $R_L = 10k\Omega$	+13.7/-14 $\pm 14.0$ $\pm 14.1$		$V_{PEAK}$ $V_{PEAK}$ $V_{PEAK}$
		$V_S = \pm 18V$ $R_L = 600\Omega$ $R_L = 2k\Omega$ $R_L = 10k\Omega$	+16.6/-16.8 $\pm 17.0$ $\pm 17.1$	$\pm 15.5$	$V_{PEAK} (min)$ $V_{PEAK}$ $V_{PEAK}$
$I_{OUT}$	Output Current	$R_L = 600\Omega$ $V_S = \pm 15V$ $V_S = \pm 18V$	$\pm 23$ $\pm 27.6/-28$	$\pm 23$	mA mA (min)
$I_{OUT-CC}$	Short Circuit Current	Sink to Source	+43 -40		mA mA
$Z_{OUT}$	Output Impedance	$f_{IN} = 10kHz$			
		Closed-Loop Open-Loop	0.01 13		$\Omega$ $\Omega$
$I_S$	Total Quiescent Power Supply Current	$I_{OUT} = 0mA$ $V_S = \pm 15V$ $V_S = \pm 18V$	12.1 12.3	16	mA mA (max)

**Note 1:** "Absolute Maximum Ratings" indicate limits beyond which damage to the device may occur, including inoperability and degradation of device reliability and/or performance. Functional operation of the device and/or non-degradation at the *Absolute Maximum Ratings* or other conditions beyond those indicated in the *Recommended Operating Conditions* is not implied. The *Recommended Operating Conditions* indicate conditions at which the device is functional and the device should not be operated beyond such conditions. All voltages are measured with respect to the ground pin, unless otherwise specified.

**Note 2:** The *Electrical Characteristics* tables list guaranteed specifications under the listed *Recommended Operating Conditions* except as otherwise modified or specified by the *Electrical Characteristics Conditions* and/or Notes. Typical specifications are estimations only and are not guaranteed.

**Note 3:** The maximum power dissipation must be derated at elevated temperatures and is dictated by  $T_{JMAX}$ ,  $\theta_{JA}$ , and the ambient temperature,  $T_A$ . The maximum allowable power dissipation is  $P_{DMAX} = (T_{JMAX} - T_A) / \theta_{JA}$  or the number given in *Absolute Maximum Ratings*, whichever is lower. For the LME49722,  $T_{JMAX} = 150^\circ C$  and the typical  $\theta_{JC}$  is  $27^\circ C/W$ .

**Note 4:** Human body model, applicable std. JESD22-A114C.

**Note 5:** Machine model, applicable std. JESD22-A115-A.

**Note 6:** Typical values represent most likely parametric norms at  $T_A = +25^\circ C$ , and at the *Recommended Operation Conditions* at the time of product characterization and are not guaranteed.

**Note 7:** Datasheet min/max specification limits are guaranteed by test or statistical analysis.

**Note 8:** PSRR is measured as follow:  $V_{OS}$  is measured at two supply voltages,  $\pm 5V$  and  $\pm 15V$ .  $PSRR = |20 \log(\Delta V_{OS} / \Delta V_S)|$ .

# Typical Performance Characteristics

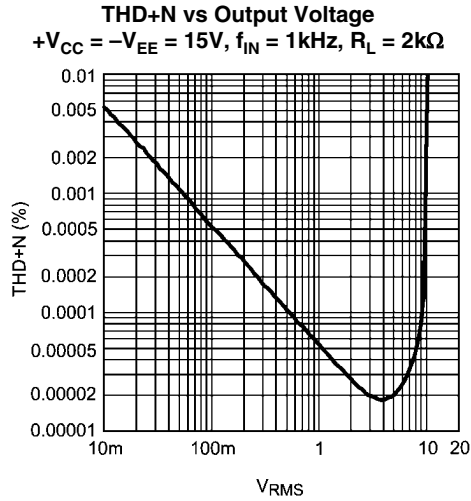

300579p5

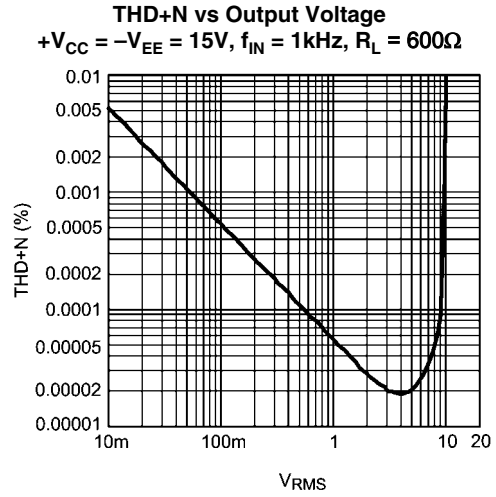

300579p6

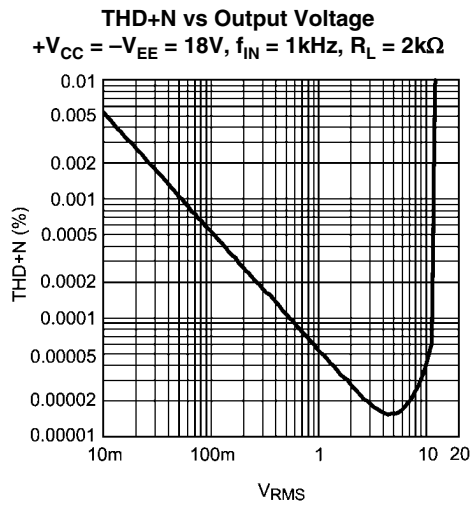

300579p7

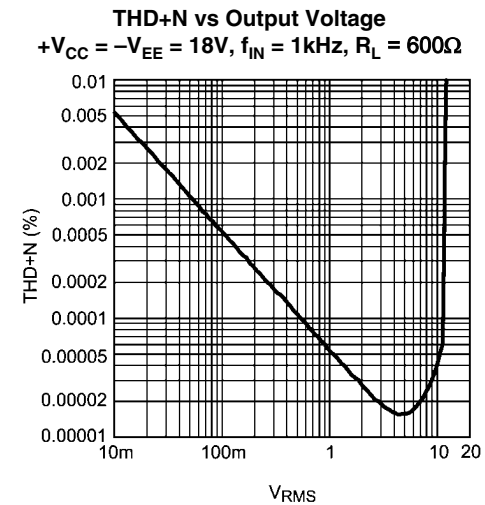

300579p8

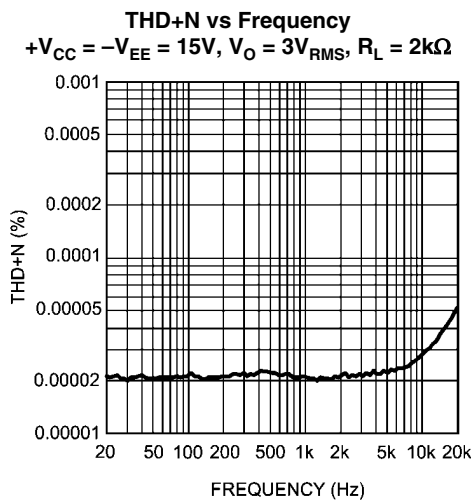

300579p1

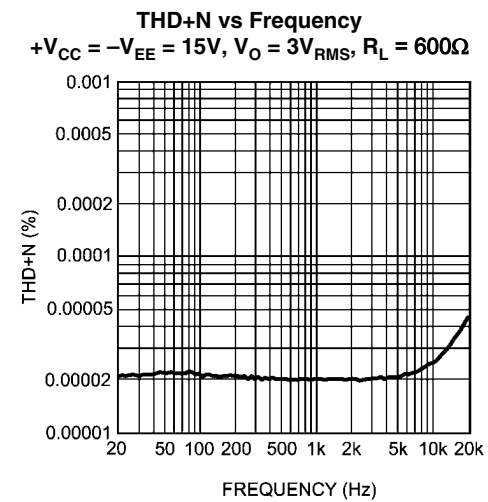

300579p2

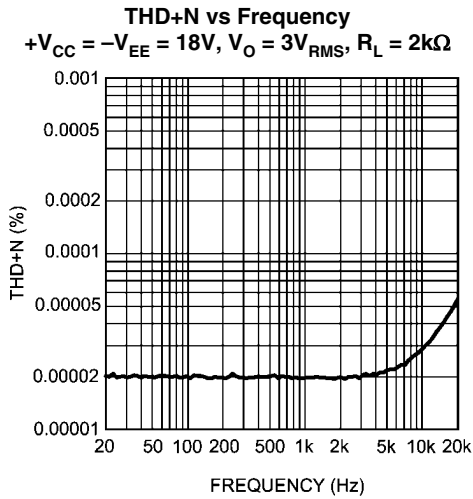

300579p3

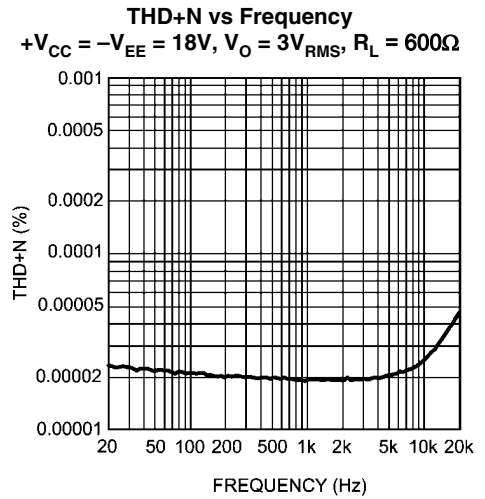

300579p4

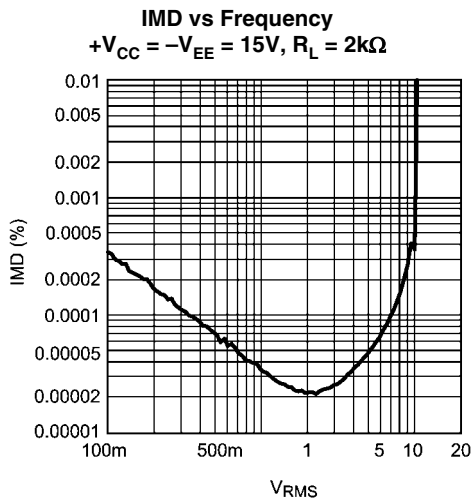

30057922

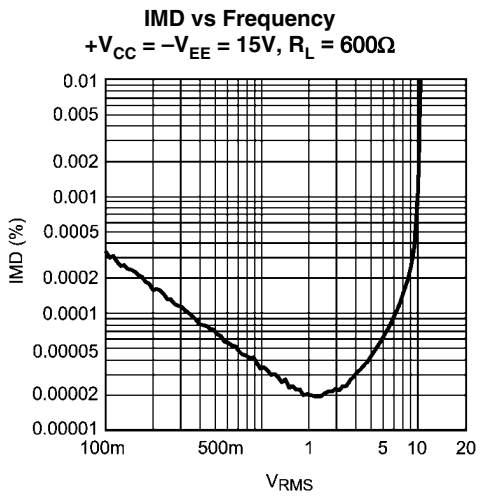

30057923

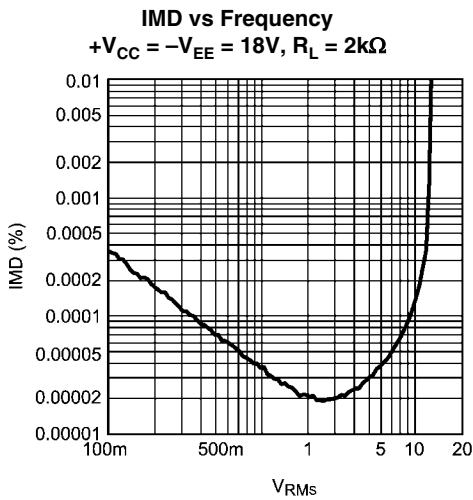

30057924

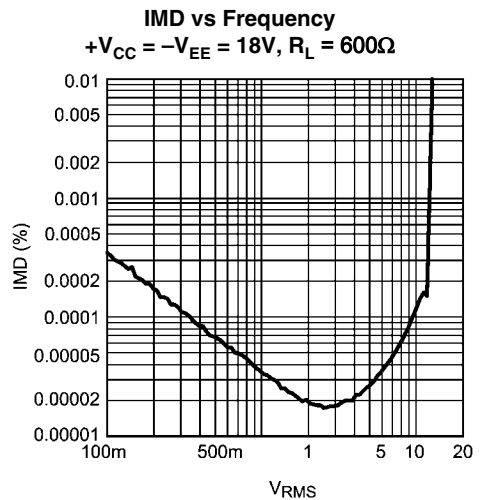

30057925

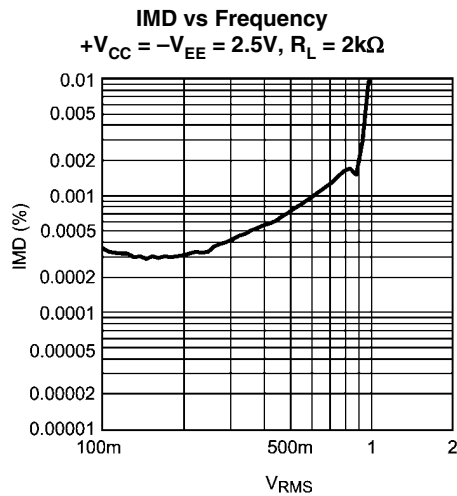

30057920

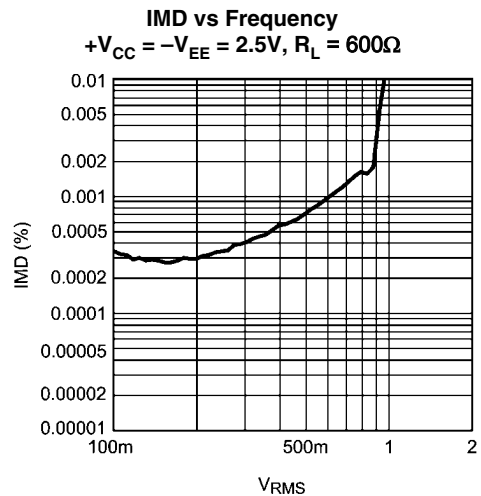

30057921

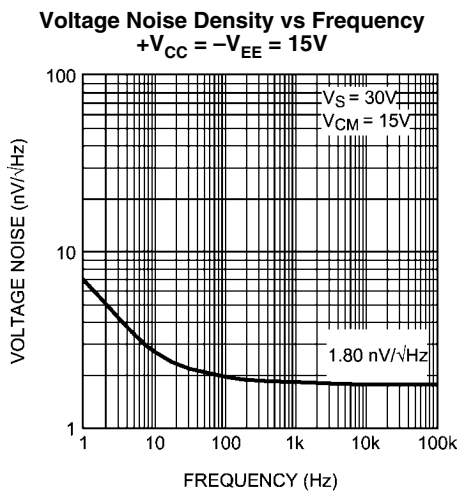

300579p9

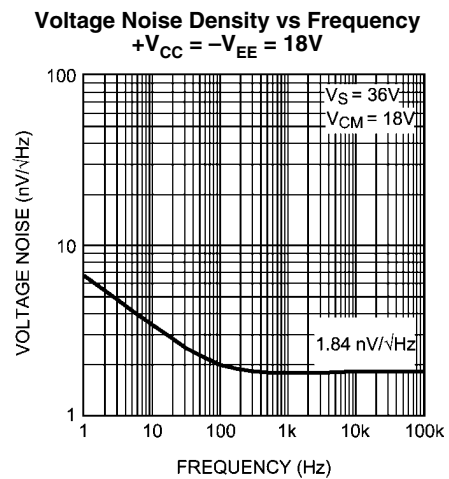

300579q0

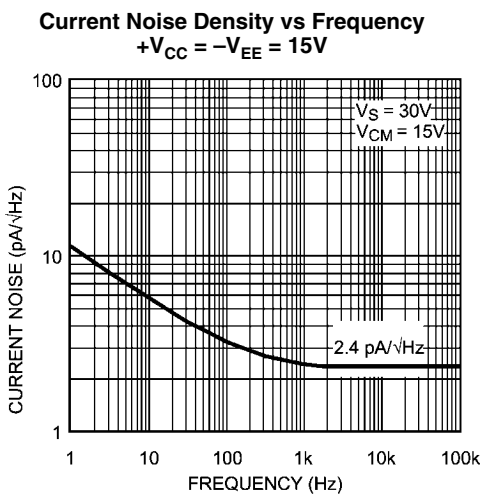

30057917

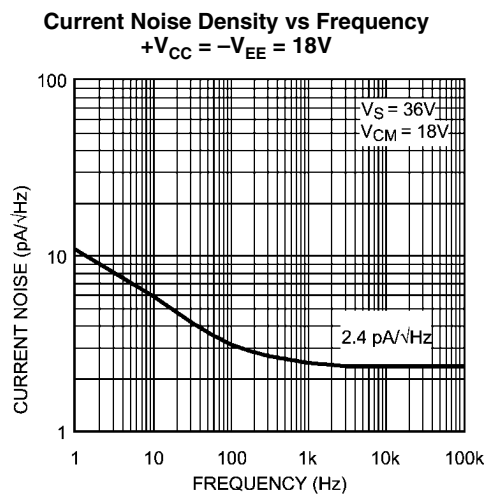

30057918

**PSRR+ vs Frequency**  
 $+V_{CC} = -V_{EE} = 15V, V_{RIPPLE} = 200mV_{PP}, R_L = 2k\Omega$

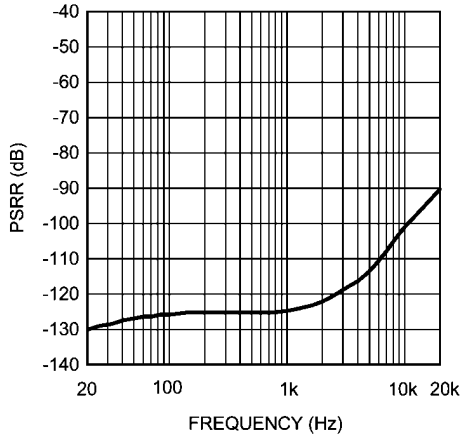

30057915

**PSRR- vs Frequency**  
 $+V_{CC} = -V_{EE} = 15V, V_{RIPPLE} = 200mV_{PP}, R_L = 2k\Omega$

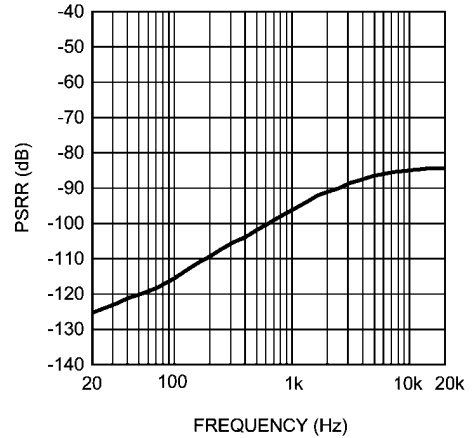

30057926

**Crosstalk vs Frequency**  
 $+V_{CC} = -V_{EE} = 15V, R_L = 2k\Omega, V_{OUT} = 3V_{RMS}$

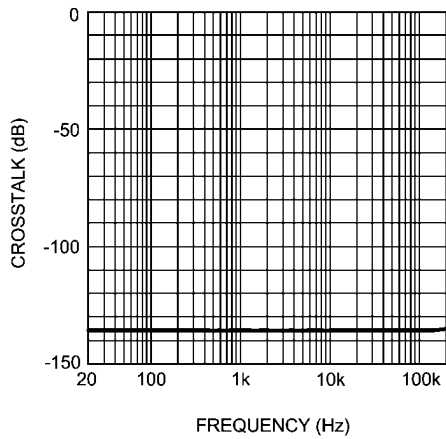

300579p0

**CMRR vs Frequency**  
 $+V_{CC} = -V_{EE} = 15V, R_L = 2k\Omega$

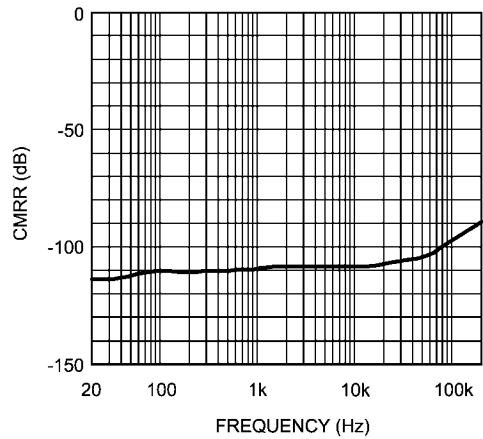

30057916

**Output Voltage vs Supply Voltage**  
 THD+N = 1%,  $R_L = 2k\Omega$

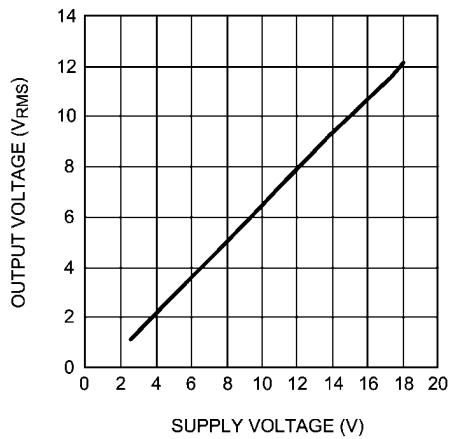

300579q1

**Output Voltage vs Supply Voltage**  
 THD+N = 1%,  $R_L = 600\Omega$

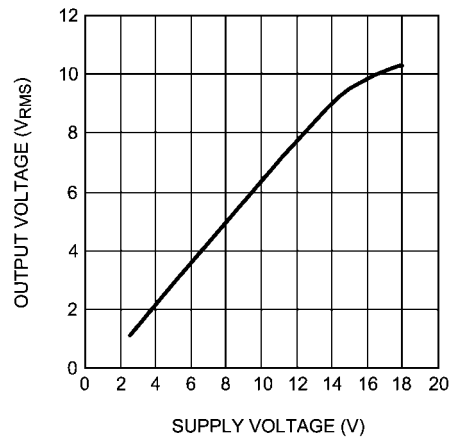

300579q2



**Supply Current vs Supply Voltage**  
 $R_L = 2k\Omega$

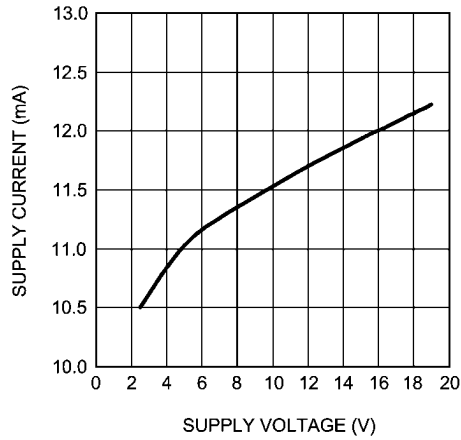

30057911

**Full Power Bandwidth vs Frequency**  
 $+V_{CC} = -V_{EE} = 15V, R_L = 2k\Omega$

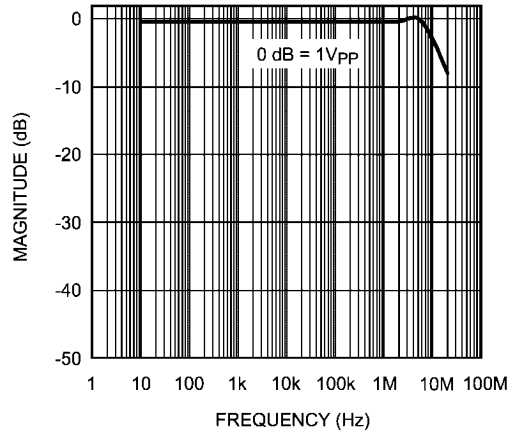

30057919

**Gain Phase vs Frequency**  
 $+V_{CC} = -V_{EE} = 15V$

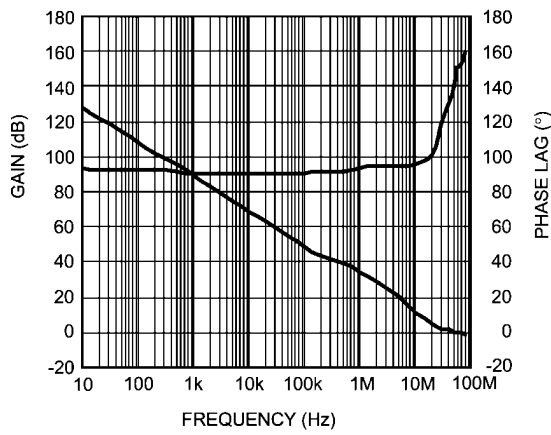

30057914

# Application Information

## APPLICATION HINTS

The LME49722 is a high speed operational amplifier which can operate stably in most of the applications. For the application with gain greater than 2, capacitive loads up to 100pF will cause little change in the phase characteristics of the am-

plifiers and are therefore allowable. Capacitive loads greater than 10pF must be isolated from the output, if the gain value is less than 2. The most straightforward way to do this is to put a resistor (its value  $\geq 20\Omega$ ) in series with the output. The resistor will also prevent unnecessary power dissipation if the output is accidentally shorted.

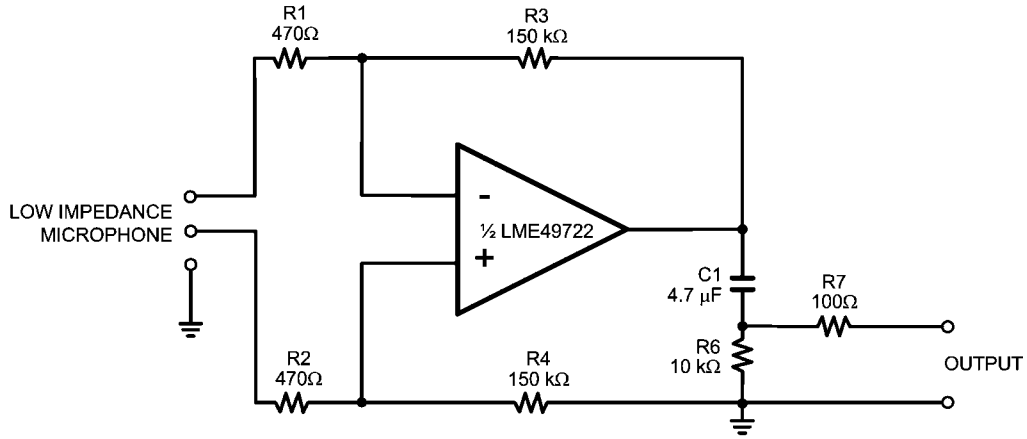

- Total voltage noise density:  $e_{N\_total}^2 \approx e_N^2 + e_{N\_R1}^2 + e_{N\_R2}^2 = 1.9^2 + 2(2.7^2)$ ,  
then  $e_{N\_total} = 4.3$  nV/√Hz. For  $e_{N\_R1} = e_{N\_R2} \approx 2.7$  nV/√Hz, if  $R1 = R2 \approx 470\Omega$ .
- Or total voltage noise = 0.13 μV input referred in a 1 kHz noise bandwidth.

30057913

FIGURE 2. Low Impedance Microphone Pre-amplifier

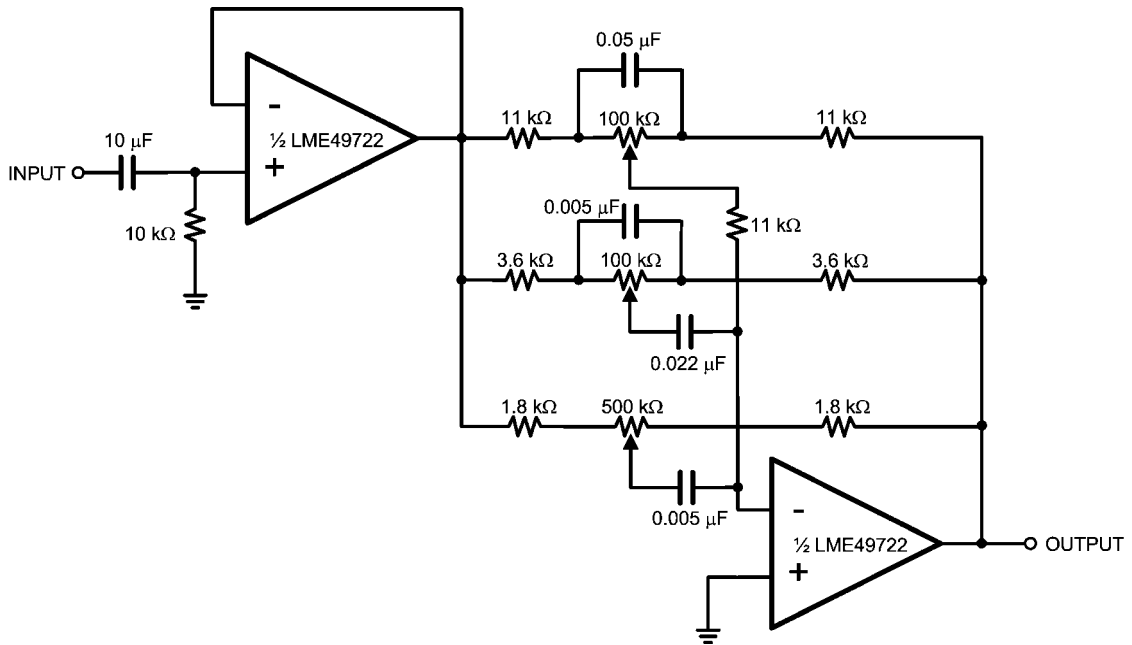

30057912

FIGURE 3. Three-Band Active Tone Control

## Revision History

Rev	Date	Description
1.0	03/27/08	Initial release.



# Notes

## Notes

For more National Semiconductor product information and proven design tools, visit the following Web sites at:

Products		Design Support	
Amplifiers	<a href="http://www.national.com/amplifiers">www.national.com/amplifiers</a>	WEBENCH	<a href="http://www.national.com/webench">www.national.com/webench</a>
Audio	<a href="http://www.national.com/audio">www.national.com/audio</a>	Analog University	<a href="http://www.national.com/AU">www.national.com/AU</a>
Clock Conditioners	<a href="http://www.national.com/timing">www.national.com/timing</a>	App Notes	<a href="http://www.national.com/appnotes">www.national.com/appnotes</a>
Data Converters	<a href="http://www.national.com/adc">www.national.com/adc</a>	Distributors	<a href="http://www.national.com/contacts">www.national.com/contacts</a>
Displays	<a href="http://www.national.com/displays">www.national.com/displays</a>	Green Compliance	<a href="http://www.national.com/quality/green">www.national.com/quality/green</a>
Ethernet	<a href="http://www.national.com/ethernet">www.national.com/ethernet</a>	Packaging	<a href="http://www.national.com/packaging">www.national.com/packaging</a>
Interface	<a href="http://www.national.com/interface">www.national.com/interface</a>	Quality and Reliability	<a href="http://www.national.com/quality">www.national.com/quality</a>
LVDS	<a href="http://www.national.com/lvds">www.national.com/lvds</a>	Reference Designs	<a href="http://www.national.com/refdesigns">www.national.com/refdesigns</a>
Power Management	<a href="http://www.national.com/power">www.national.com/power</a>	Feedback	<a href="http://www.national.com/feedback">www.national.com/feedback</a>
Switching Regulators	<a href="http://www.national.com/switchers">www.national.com/switchers</a>		
LDOs	<a href="http://www.national.com/lido">www.national.com/lido</a>		
LED Lighting	<a href="http://www.national.com/led">www.national.com/led</a>		
PowerWise	<a href="http://www.national.com/powerwise">www.national.com/powerwise</a>		
Serial Digital Interface (SDI)	<a href="http://www.national.com/sdi">www.national.com/sdi</a>		
Temperature Sensors	<a href="http://www.national.com/tempsensors">www.national.com/tempsensors</a>		
Wireless (PLL/VCO)	<a href="http://www.national.com/wireless">www.national.com/wireless</a>		

THE CONTENTS OF THIS DOCUMENT ARE PROVIDED IN CONNECTION WITH NATIONAL SEMICONDUCTOR CORPORATION ("NATIONAL") PRODUCTS. NATIONAL MAKES NO REPRESENTATIONS OR WARRANTIES WITH RESPECT TO THE ACCURACY OR COMPLETENESS OF THE CONTENTS OF THIS PUBLICATION AND RESERVES THE RIGHT TO MAKE CHANGES TO SPECIFICATIONS AND PRODUCT DESCRIPTIONS AT ANY TIME WITHOUT NOTICE. NO LICENSE, WHETHER EXPRESS, IMPLIED, ARISING BY ESTOPPEL OR OTHERWISE, TO ANY INTELLECTUAL PROPERTY RIGHTS IS GRANTED BY THIS DOCUMENT.

TESTING AND OTHER QUALITY CONTROLS ARE USED TO THE EXTENT NATIONAL DEEMS NECESSARY TO SUPPORT NATIONAL'S PRODUCT WARRANTY. EXCEPT WHERE MANDATED BY GOVERNMENT REQUIREMENTS, TESTING OF ALL PARAMETERS OF EACH PRODUCT IS NOT NECESSARILY PERFORMED. NATIONAL ASSUMES NO LIABILITY FOR APPLICATIONS ASSISTANCE OR BUYER PRODUCT DESIGN. BUYERS ARE RESPONSIBLE FOR THEIR PRODUCTS AND APPLICATIONS USING NATIONAL COMPONENTS. PRIOR TO USING OR DISTRIBUTING ANY PRODUCTS THAT INCLUDE NATIONAL COMPONENTS, BUYERS SHOULD PROVIDE ADEQUATE DESIGN, TESTING AND OPERATING SAFEGUARDS.

EXCEPT AS PROVIDED IN NATIONAL'S TERMS AND CONDITIONS OF SALE FOR SUCH PRODUCTS, NATIONAL ASSUMES NO LIABILITY WHATSOEVER, AND NATIONAL DISCLAIMS ANY EXPRESS OR IMPLIED WARRANTY RELATING TO THE SALE AND/OR USE OF NATIONAL PRODUCTS INCLUDING LIABILITY OR WARRANTIES RELATING TO FITNESS FOR A PARTICULAR PURPOSE, MERCHANTABILITY, OR INFRINGEMENT OF ANY PATENT, COPYRIGHT OR OTHER INTELLECTUAL PROPERTY RIGHT.

### LIFE SUPPORT POLICY

**NATIONAL'S PRODUCTS ARE NOT AUTHORIZED FOR USE AS CRITICAL COMPONENTS IN LIFE SUPPORT DEVICES OR SYSTEMS WITHOUT THE EXPRESS PRIOR WRITTEN APPROVAL OF THE CHIEF EXECUTIVE OFFICER AND GENERAL COUNSEL OF NATIONAL SEMICONDUCTOR CORPORATION.** As used herein:

Life support devices or systems are devices which (a) are intended for surgical implant into the body, or (b) support or sustain life and whose failure to perform when properly used in accordance with instructions for use provided in the labeling can be reasonably expected to result in a significant injury to the user. A critical component is any component in a life support device or system whose failure to perform can be reasonably expected to cause the failure of the life support device or system or to affect its safety or effectiveness.

National Semiconductor and the National Semiconductor logo are registered trademarks of National Semiconductor Corporation. All other brand or product names may be trademarks or registered trademarks of their respective holders.

Copyright© 2008 National Semiconductor Corporation

For the most current product information visit us at [www.national.com](http://www.national.com)



**National Semiconductor  
Americas Technical  
Support Center**  
Email:  
[new.feedback@nsc.com](mailto:new.feedback@nsc.com)  
Tel: 1-800-272-9959

**National Semiconductor Europe  
Technical Support Center**  
Email: [europe.support@nsc.com](mailto:europe.support@nsc.com)  
German Tel: +49 (0) 180 5010 771  
English Tel: +44 (0) 870 850 4288

**National Semiconductor Asia  
Pacific Technical Support Center**  
Email: [ap.support@nsc.com](mailto:ap.support@nsc.com)

**National Semiconductor Japan  
Technical Support Center**  
Email: [jpn.feedback@nsc.com](mailto:jpn.feedback@nsc.com)